

DATENBLATT / FACT SHEET



	Nimbus	Häfele
Cubic 36 Connect	562-309	833.67.766

Cubic 36 Connect

DECKENLEUCHTE (LEUCHTENKOPF) MIT ACRYL-DIFFUSOR UND DRAHTLOSER STEUERUNG
 CEILING DOWNLIGHT (LUMINAIRE HEAD) WITH ACRYLIC DIFFUSOR AND WIRELESS CONTROL

Kubische LED-Deckenleuchte, sehr homogener und weicher Lichtaustritt durch satinierte, geschlossene Diffusorfläche, breit abstrahlend, zusätzliche Deckenaufhellung sowie sehr gleichmäßige, nahezu raumhohe Wandaufhellung durch Sekundärlicht, formale Gestaltung passend zu den Nimbus-Familien Modul Q und Q Four, Deckenring für Direktmontage liegt bei, durch optionales Zubehör entstehen verschiedene modulare Anbindungsmöglichkeiten an die Decke, Farbtemperatur stufenlos einstellbar (tunable white), drahtloses Steuern und Dimmen erfolgt über die Häfele Connect Mesh App (basierend auf **Bluetooth**[®] wireless technology), Ausführung für 24 V DC mit Loox5-Stecker, passendes Anschluss-Zubehör sowie weitere Häfele Connect-Aktoren bitte separat bestellen.

Cubical LED ceiling luminaire, very uniform and smooth light distribution by means of a satin-frosted and closed diffuser surface, wide beam, additional ceiling lighting and a very even, almost floor-to-ceiling illumination of walls by secondary light, design formally adapting to the Nimbus families Modul Q and Q Four, ceiling ring for direct mounting included, optional accessories create various modular mounting options to the ceiling, colour temperature continuously adjustable (tunable white), wireless control and dimming takes place via the Häfele Connect Mesh app (based on **Bluetooth**[®] wireless technology), version for 24 V DC with Loox5 connector, please order suitable connection accessories and additional Häfele Connect actuators separately.

The Bluetooth[®] word mark and logos are registered trademarks owned by Bluetooth SI, Inc. and any use of such marks by Häfele SE & Co KG is under license. Other trademarks and trade names are those of their respective owners.

The Bluetooth[®] word mark and logos are registered trademarks owned by Bluetooth SI, Inc. and any use of such marks by Häfele SE & Co KG is under license. Other trademarks and trade names are those of their respective owners.

TECHNISCHE DATEN / TECHNICAL FACTS

Artikel:

Cubic 36 Connect

Art.-Nr.

562-309 / 833.67.766

Beschreibung/Ausführung:

kubische Deckenleuchte mit drahtloser Steuerung

Hersteller:

Nimbus Group GmbH

Sieglestr. 41, 70469 Stuttgart / Germany

Tel.: +49(0)711 / 63 30 14 - 0

www.nimbus-group.com / info@nimbus-group.com

Abmessungen / Gewicht:

122 x 122 x 21 mm / ca. 260 Gramm

Material:

Korpus: Acrylglas

Rückblech: Aluminium

Montage über Rasthaken oder rückseitige Magnete

Anschlussleistung:

7,5 W / 24 Volt DC (SELV)

Anzahl LED / Lichtverteilung:

72 Stück / 100 % direkt, breit abstrahlend

Nutzlichtstrom / lm pro Watt:

Farbtemperatur einstellbar (tunable white) 2700-5000K

555 lm @ 2700K / 74 lm/W, 690 lm @ 5000K / 92 lm/W

RA / Farbtoleranz:

> 90 / 3 SDCM

mittlere Bemessungslebensdauer

L80 B10 > 50 000 Stunden

ta:

15-40 °C / 59-104 °F

Gehäuseschutzart / elektrische Schutzklasse:

IP 20 / SK III

Steuerung / Dimmung:

erfolgt über die Häfele Connect Mesh App

(basierend auf **Bluetooth**® wireless technology)

Frequenzband: 2402-2480 MHz

max. Antennenleistung: +4 dBm

Prüfzeichen:

Dieses Produkt enthält Lichtquellen der Energieeffizienzklasse F.

Reinigungs- und Pflegehinweise:

Leuchte vor dem Reinigen ausschalten. Keine ätzenden oder abrasiven Reinigungsmittel verwenden, sondern Leuchte z.B. mit einem Microfasertuch trocken reinigen.

Alle Angaben erfolgen ohne Gewähr für Irrtümer und Übertragungsfehler. Wir bitten um Verständnis, dass wir uns Änderungen in der Gestalt und Technik vorbehalten.

product:

Cubic 36 Connect

item no.

562-309 / 833.67.766

description/design:

cubical ceiling luminaire with wireless control

manufacturer:

Nimbus Group GmbH

Sieglestr. 41, 70469 Stuttgart / Germany

Tel.: +49(0)711 / 63 30 14 - 0

www.nimbus-group.com / info@nimbus-group.com

dimensions / weight:

122 x 122 x 21 mm / approx. 260 grams

materials:

body: acrylic glass

back cover: aluminium

mounting via snap-in hooks or magnets on the back

power consumption:

7.5 W / 24 volts DC (SELV)

number of LED / light distribution:

72 pcs / 100 % direct beam, wide beam

luminous flux / lumens per watt:

colour temperature adjustable (tunable white) 2700-5000K

555 lm @ 2700K / 74 lm/W, 690 lm @ 5000K / 92 lm/W

CRI / colour tolerance:

> 90 / 3 SDCM

average rated life:

L80 B10 > 50 000 hours

ta:

15-40 °C / 59-104 °F

degree of protection / IEC protection class:

IP 20 / Class III

control / dimming:

via the Häfele Connect Mesh app

(based on **Bluetooth**® wireless technology)

frequency band: 2402-2480 MHz

max. antenna power: +4 dBm

certificates:

This product contains light sources of energy efficiency class F.

cleaning and care:

Switch off luminaire before cleaning. Do not use any corrosive or abrasive cleanser. We recommend to clean the luminaire with a dry microfibre towel only.

The information may be subject to errors in content or transmission errors; we do not accept responsibility for any such errors. We reserve the right to make changes to design and technology and apologise for any inconvenience this may cause.

LICHTVERTEILUNG LIGHT DISTRIBUTION

Lichtverteilungskurve
light distribution curve

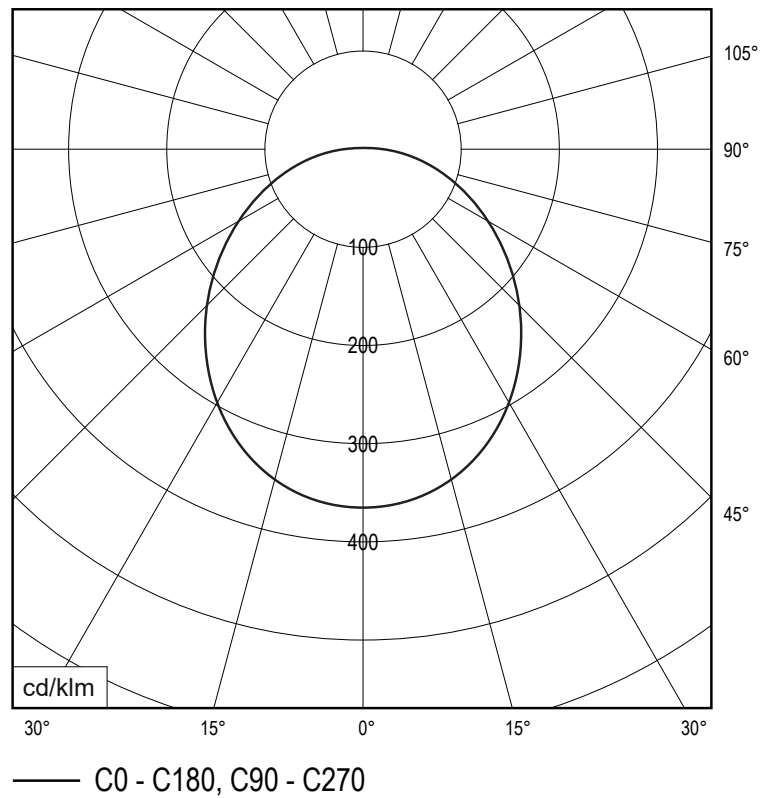

Abstrahlcharakteristik
directional characteristics



ISOMETRIE UND ABMESSUNGEN / SIZES



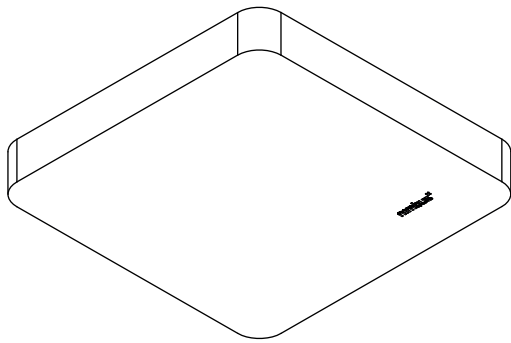

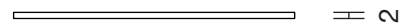
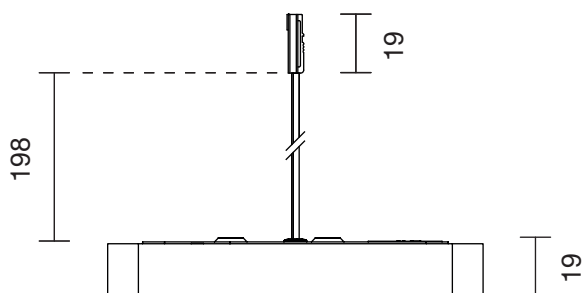
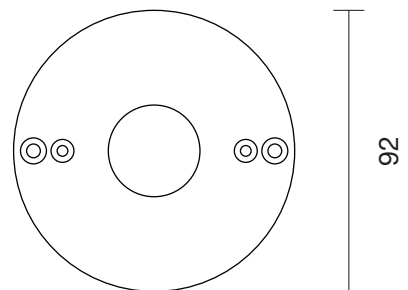
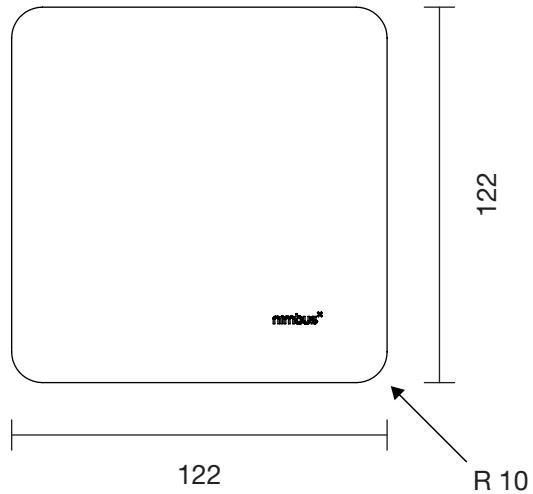
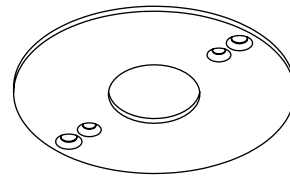

Leuchtenkopf
luminaire head

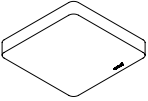
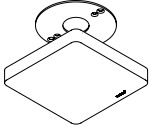

Deckenring für Direktmontage
ceiling ring for direct mounting

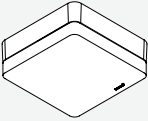
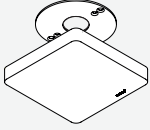
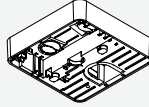

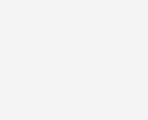
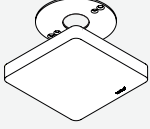
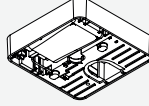
BESTELLVARIANTEN / ORDERING OPTIONS

	Bestellnummer sales item order number	Verkaufsartikel sales item order number	bestehend aus folgenden Einzelkomponenten consisting of the following components	optional optional
<p>Cubic 36 Connect ON</p> 		<p>24 V DC</p> <p>562-309 833.67.766</p>		 <p>562-337 833.67.779</p>
<p>Cubic 36 Connect ON-X</p> <p>weiß / white schwarz / black</p> 		<p>24 V DC</p> <p>562-649 833.67.984 562-650 833.67.985</p>	<p>bestehend aus / consisting of</p>  <p>+</p>  <p>● 562-342 / 833.67.783 ○ 562-343 / 833.67.784</p>	 <p>562-337 833.67.779</p>
<p>Cubic 36 Connect ON-XD</p> <p>weiß / white schwarz / black</p> 		<p>230 V</p> <p>562-647 833.67.982 562-648 833.67.983</p>	 <p>+</p>  <p>● 562-340 / 833.67.781 ○ 562-341 / 833.67.782</p>	 <p>562-337 833.67.779</p>